

Part. "Z"

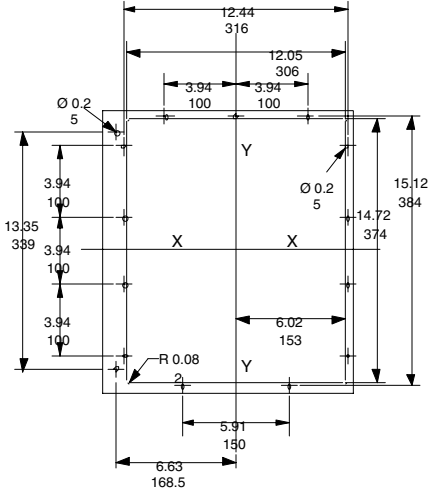
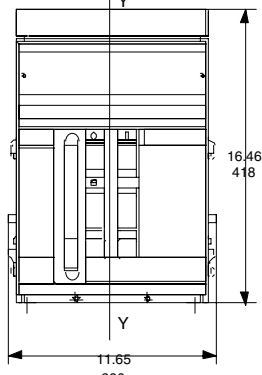
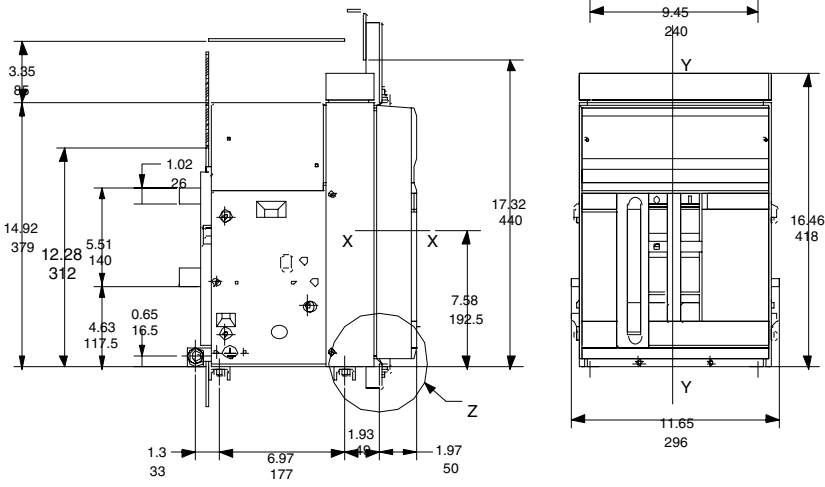

ABB Control Inc.

REFERENCE NUMBER: 933860-E2

E2 FIXED WITH HORIZONTAL REAR TERMINALS

FILE NAME  
E2-FHRT.DXF  
REV. A